

BRIDGE TYPE MACHINING CENTER



SUZHOU GUDWAY CNC EQUIPMENT CO.,LTD

Add : No. 21 Xiexin Road, New District, Suzhou City, Jiangsu Province, China.

Tel : +86-0512-65580060

Email : info@gudwaycnc.com

Web : <http://www.gudwaycnc.com>

SUZHOU GUDWAY CNC EQUIPMENT CO.,LTD



GDC SERIES

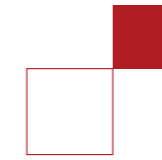

- One piece casting bed and bridge structure, providing stable rigid foundation.
- Z-axis direct rail connection type 800mm stroke, can also be selected with gear head.
- Symmetrical design of main spindle, with double balance cylinder, fast response up and down.

HIGH PERFORMANCE BRIDGE TYPE MACHINING CENTER

Adhering to Gudway traditional structural design. Focus on the best materials and components as the basis of high precision products, with solid and reasonable light weight design balance principle for the product to create a high rigidity and high stability required for high-speed cutting products.



GDC SERIES



GDC SERIES



- GDC series X-axis guide way adopts the heavy-duty type roller way with a width of 55 mm, with three overweight load type roller way supporting the worktable. Cooperate with the low friction coefficient line rail, which can effectively keep the smooth sliding of the table when it is loaded. so that the displacement accuracy is better than that of the hard rail.
- Large -size beam, Y axis orbit line rail stepped structure design. The upper track is placed above the beam and the lower track is close to the spindle, sharply increasing beam with two guide rails' span. Z axis with greater travel at the same time also has a higher accuracy stability and cutting rigidity.
- Wide span column structure provides optimal machining rigidity. The headstock retains stability and accuracy even under high speed traveling.



型号	Worktable size	轨道跨距	底座宽度
GDC series	2400/2500mm	862mm	2200mm
GDC series	3000mm	1100mm	2700mm

HIGH PERFORMANCE BRIDGE TYPE MACHINING CENTER

Series of product line, modular design, specifications complete. It can be matched with a variety of additional head accessories to realize the advantages of automation, high efficiency and high productivity.

- GDC Series X-axis guide-way adopts 55mm heavy-duty roller-way, symmetrical four track full support worktable, and low friction coefficient track, which can effectively maintain the smooth sliding characteristics, When the workbench is loaded, and make the displacement accuracy surpass the traditional hard rail performance.
- Our welding base & castings column are characterized by the effective absorption of vibration force from machining on the structural ribs.
- Super rigidity roller liner guide way achieves fast movement with low abrasion from linear guide way which completely improves rigidity and control of the machine.



HIGH PERFORMANCE BRIDGE TYPE MACHINING CENTER



HIGH TORQUE GEAR SPINDLE

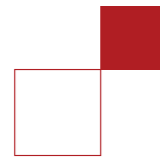

SYMMETRICAL BALANCE DESIGN OF SPINDLE CENTER

STRONG STABILITY DURABILITY AND SCALABILITY



WITH ALL KINDS OF DIFFERENT PROCESSING NEEDS, CHOOSING VARIOUS SPEED SPINDLE GEAR 600ORPM, DIRECTTYPE 8000/1000ORPM.



Face milling

Tool diameter: 125mm
Material removal rate: 750c.c/min

End milling

Tool diameter: 25mm
Feed rate: 500c.c/min

U Drilling

Drill tool diameter: 32mm
Cutting feed: 550c.c/min



- The minimum distance design between the center of the spindle and Z-axis rail, shortening the cutting force arm to improve cutting rigidity greatly.
- The spindle, the Z-axis screw, the center line of the spindle and the center line of the motor are symmetrically arranged on the Z-axis box-way structure with the same center point, providing the best stable movement of the Z-axis.
- Gear type spindle adopts imported precision gear, with high precision, low noise and high transmission efficiency performance.
- Gear type spindle adopts two-step automatic gear change to provide high torque and high-speed cutting rigidity characteristics of heavy cutting, so as to ensure heavy cutting ability and smooth surface.
- The output torque leading industry for more than 15%, providing excellent heavy cutting performance.
- Spindle speed 6,000rpm, Maximum torque 236Nm(15/18.5kW), 759Nm(22/26kW).

SPINDLE TORQUE GRAPH

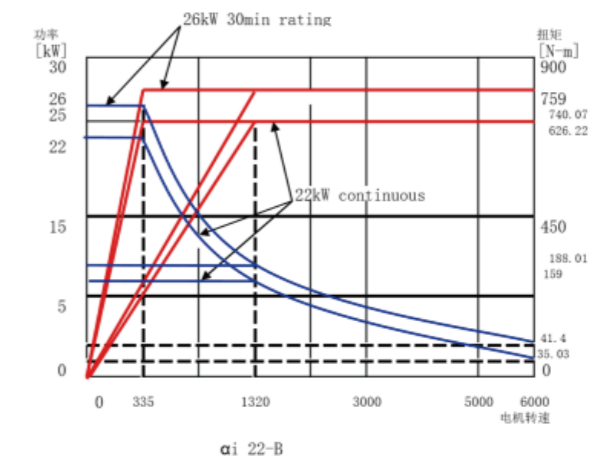
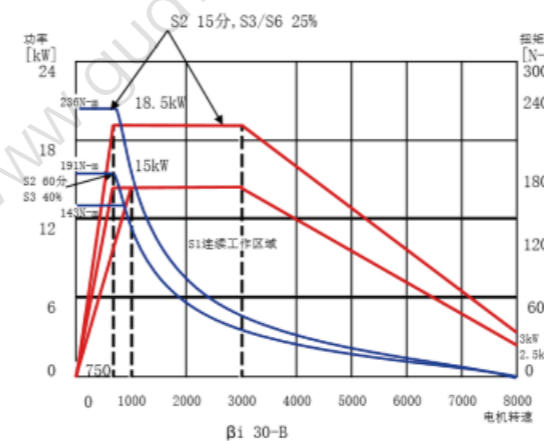

SCRAPING PROCESS

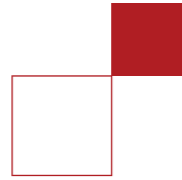

Precision assembly is the most important part during processing; to ensure the precision, Gudway's assembly is completed by ourselves; to ensure the precision and quality, we stress every detail; after strict examination and record, we will go on the next process to ensure the best precision of every machine.

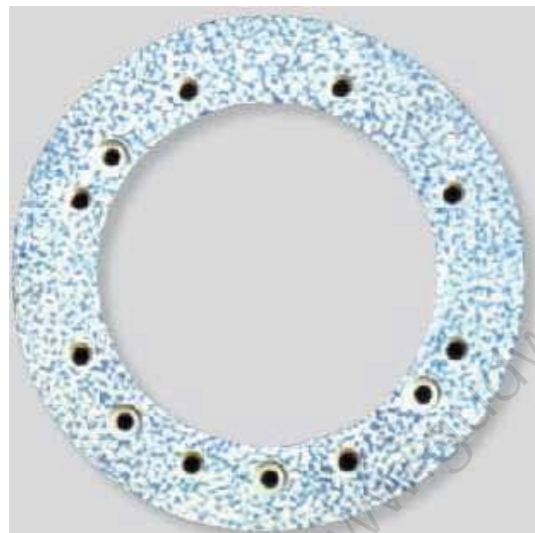

Spindle head of the joint surface scraping

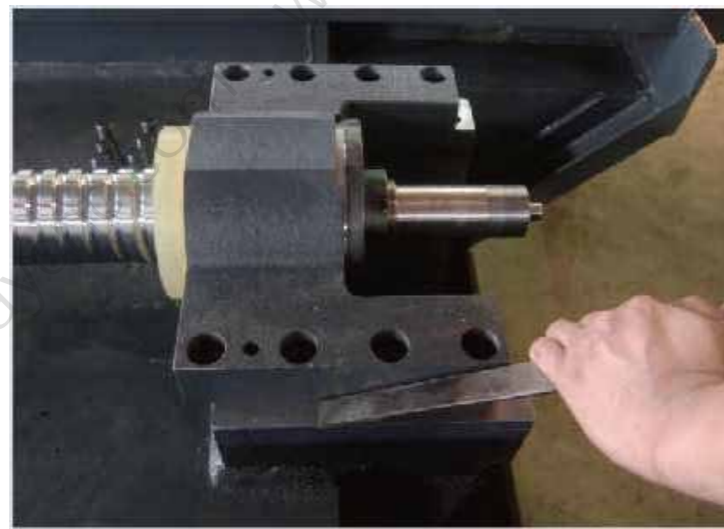

Screw assembly and calibration

- ◆ The spindle head of the joint surface and the motor board are handled by scraping, to ensure the best function and precision.



Craftsmanship
Exquisitely crafted

SCRAPING PROCESS

Scraping is a finishing process that uses scraper, reference surface, measuring tool and display agent to manually operate, while grinding, measuring and scraping, so that the work piece can meet the requirements of size, geometry, surface roughness and tightness specified in the process. Because the tools used are simple, universal, less machining allowance, and the accuracy is very high, they are widely used in the manufacturing of machines and tools and the repair of mechanical equipment. Generally, the guide rail, carriage and bearing bush of the sliding bearing of the machine tool are all finished by scraping.

MEASURING EQUIPMENT

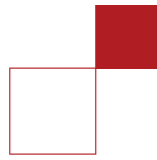

Spindle vibration detecting



The spindle temperature detecting



On-line balancing debugging

FIRST-CLASS PROCESSING EQUIPMENT TO ENSURE HIGH QUALITY AND PRECISION

- Spindle temperature testing, operating after 24 hours detecting the temperature.
- Spindle test rod examination to ensure the precision between the certicality of the spindle and the spindle taper and shank.
- Laser examination, all movement precision by laser calibration compensation, to ensure repeated positioning precision of the machine.
- Spindle pull testing, detecting the broach force of the spindle to ensure the tool's clamping force when processing. geometric precision testing, detecting the parallelism and verticality of each axis.
- Spindle shock examination, including each speed range of the spindle, requiring less than 3μm to ensure the good processing precision.
- Ballbar roundness examination, adjusting the roundness and geometric precision to ensure the machine's three dimensional space movement precision.

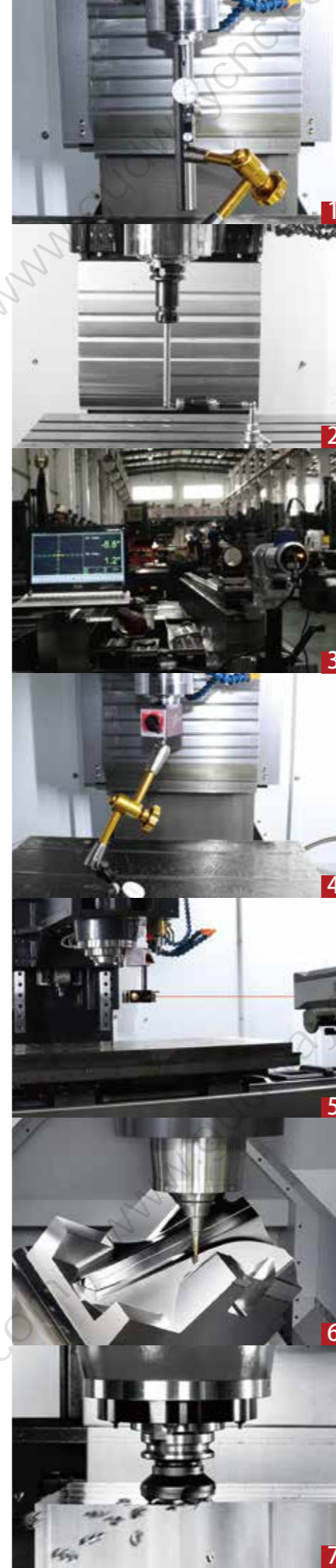

COMPLETE QUALITY TESTING PROCESS TO CREATE PERFECT TECHNOLOGY

- 1 SPINDLE TEST BAR TESTING
- 2 BALLBAR ROUNDNESS TESTING
- 3 COLLIMATOR DETECTING RAIL STRAIGHTNESS
- 4 GEOMETRIC PRECISION DETECTING
- 5 LASER POSITIONING DETECTION
- 6 3D DIE & MOLD SERVO ADJUSTMENT
- 7 HEAVY CUTTING ABILITY TESTING



Each process in accordance with the P-D-C-A control processes of quality plan

Advanced testing equipment and strict quality standard to achieve the quality first commitment

PRECISION ASSEMBLY

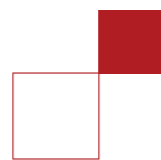

Production Workshop



The photoelectric autocollimator check I



Toordinate Measuring Machine



The photoelectric autocollimator check II

GUARANTEERING THE BEST PRECISION OF EVERY MACHINE



Spindle Coupling correction



Spindle Dry Run



Bearing seat correction



Ball-screw correction

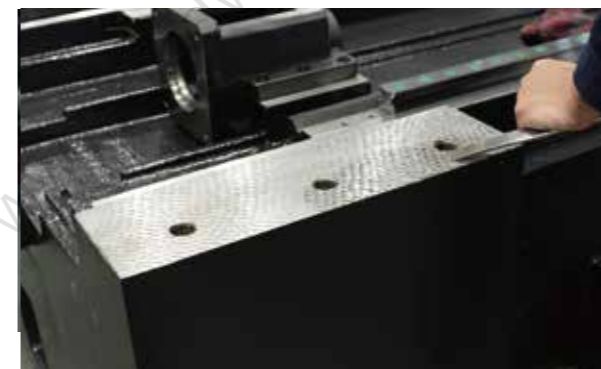

Base Scraping



Three coordinate measurement system

Multiple options, modular angle head

FINELY CRAFTED TOP-LEVEL FUNCTIONALITY



◀ Manually 90° Rectangular milling head (X55)

Maximum speed: 2500rpm
Maximum torque: 1200N-m

model: A82A (Mingyang)
C-axis manual 5 / 15 degrees per scale



Model: M58S01C (rishen)
C-axis manual 5 degrees one degree

Automatic 90° Rectangular milling head (M55) ▶

Maximum speed: 3500rpm
Maximum torque: 1000N-m



Model: A55M14 (rishen)
C-axis manual 5 degrees one degree



◀ Off-axis universal milling head (X57)

Maximum speed: 2500rpm
Maximum torque: 1000N-m

Model: A90
C-axis manual 5 degrees one degree
A axis manual one-point degree



Model: M58S01
C axis automatically 5 degrees one degree
A axis manual one-point degree



A Chain type Magazines

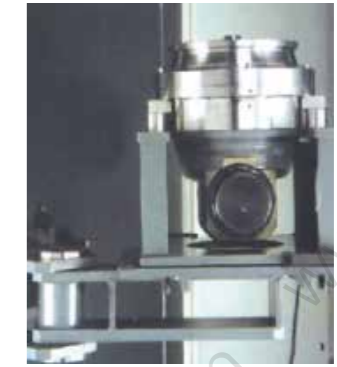

B Swinging Arm Head Storage



C Ring coolant system



D Automatic tool length measurement system



E Coolant through Spindle system



F Work piece measurement system

C The water spray device around the spindle can make the work piece and tools cool well.

E Coolant through spindle can directly cool the work piece and cutting tip of tool, and take away the cutting heat source, to ensure the processing quality and be suitable for the parts with deep hold processing.

F Using HEXAGON work piece measurement system

IRP 25.5 Convenient for measurement, saving more than 50% time when processing and reducing rejection rate, reducing the cost, improving processing control.

IRP 25.5 probe use small and light Micro-electronic devices, so compactness.

Probe can be equipped with the latest IRR91.50 integrated interface receiver; the system uses the most advanced modulated optical transmission method, with the ability of resistance to light interference.

Probe equipped with a 360° infrared optical transmission system, the transmission distance of 6m, can be measured on any direction.

DIMENSION OF MACHINE LAYOUT

MACHANCAL APPERANCE DIMENSIONS

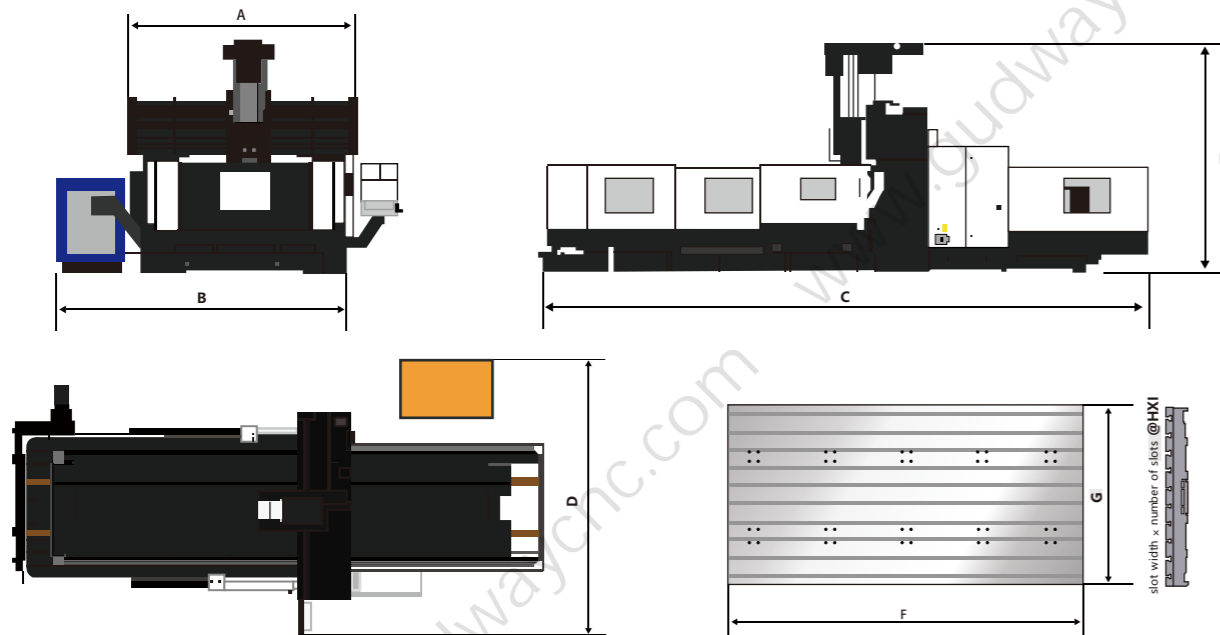

Item	Appearance parameters					Table parameters			
	A	B	C	D	E	F	G	H	I
graphic	A	B	C	D	E	F	G	H	I
GDC2013	2600	3700	6300	4600	4300	2000	1100	160	7
GDC2018	3300	4100	6300	5000	4500	2020	1610	200	8
GDC2518	3300	4100	7500	5000	4500	2520	1610	200	8
GDC3018	3300	4200	8500	5000	4500	3020	1610	200	8
GDC3022	3700	5000	8600	5500	4500	3020	2010	200	10
GDC3028Z	4600	5000	8600	6500	5100	3020	2010	200	10
GDC4028Z	4600	5000	11000	6500	5100	4020	2010	200	10
GDC3032Z	5100	5500	8600	5700	5200	3020	2010	200	10
GDC4032Z	5100	5500	11000	5700	5200	4020	2410	200	12
GDC5032Z	5100	5500	13000	5700	5200	5020	2410	200	12
GDC5040Z	6000	6200	13000	7600	5200	5020	2410	200	12
GDC6532Z2	5100	5500	15800	6500	6400	6020	2410	200	12
GDC6540Z2	6000	6200	15800	7600	6400	6020	3010	200	14
GDC6547Z2	6700	7000	15800	8300	6400	6020	3010	200	14
GDC8540Z2	6000	6200	19500	7600	6400	8020	3010	200	14
GDC8547Z2	6700	7000	19500	8300	6400	8020	3010	200	14
GDC10040Z2	6000	6200	22700	7600	6400	10020	3010	200	14
GDC10047Z2	6700	7000	22700	8300	6400	10020	3010	200	14

DISTANCE FOR SPINDLE NOSE TO WORK TABLE

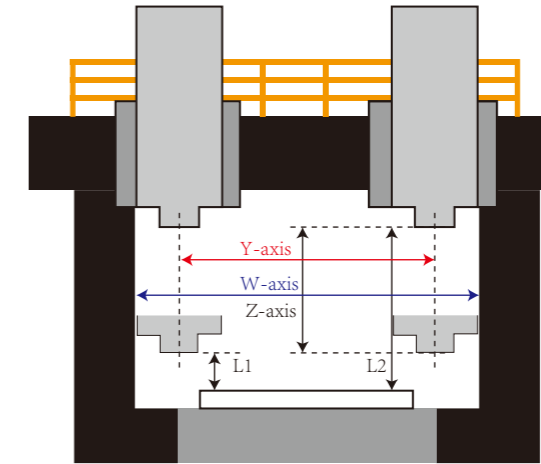

graphic	gear type	Spindle taper hole							L1	L2
		L1	L2	Y	Z	W	Direct drive			
GDC2013	gear type	200	1000	1200	800	1300	Direct drive	200	1000	
GDC2018	gear type	200	1000	1800	800	1900	Direct drive	200	1000	
GDC2518	gear type	200	1000	1800	800	1900	Direct drive	320	1120	
GDC3018	gear type	200	1000	1800	800	1900	Direct drive	320	1120	
GDC3022	gear type	280	1080	2200	800	2300	Direct drive	280	1080	
GDC3028Z	gear type	200	1000	2800	1000	2300	Direct drive	230	1230	
GDC4028Z	gear type	200	1200	2800	1000	2300	Direct drive	230	1230	
GDC3032Z	gear type	200	1200	3200	1000	2700	Direct drive	230	1230	
GDC4032Z	gear type	200	1200	3200	1000	2700	Direct drive	230	1230	
GDC5032Z	gear type	200	1200	3200	1000	2700	Direct drive	230	1230	
GDC5040Z	gear type	200	1200	4000	1000	3500	Direct drive	200	1200	
GDC6532Z2	gear type	315	1515	3200	1200	2700	Direct drive	350	1550	
GDC6540Z2	gear type	315	1515	4000	1200	3500	Direct drive	350	1550	
GDC6547Z2	gear type	315	1515	4700	1200	4200	Direct drive	350	1550	
GDC8540Z2	gear type	315	1515	4000	1200	3500	Direct drive	350	1550	
GDC8547Z2	gear type	315	1515	4700	1200	4200	Direct drive	350	1550	
GDC10040Z2	gear type	315	1515	4700	1200	3500	Direct drive	350	1550	

TOOLHOLDER AND BOLT SIZE

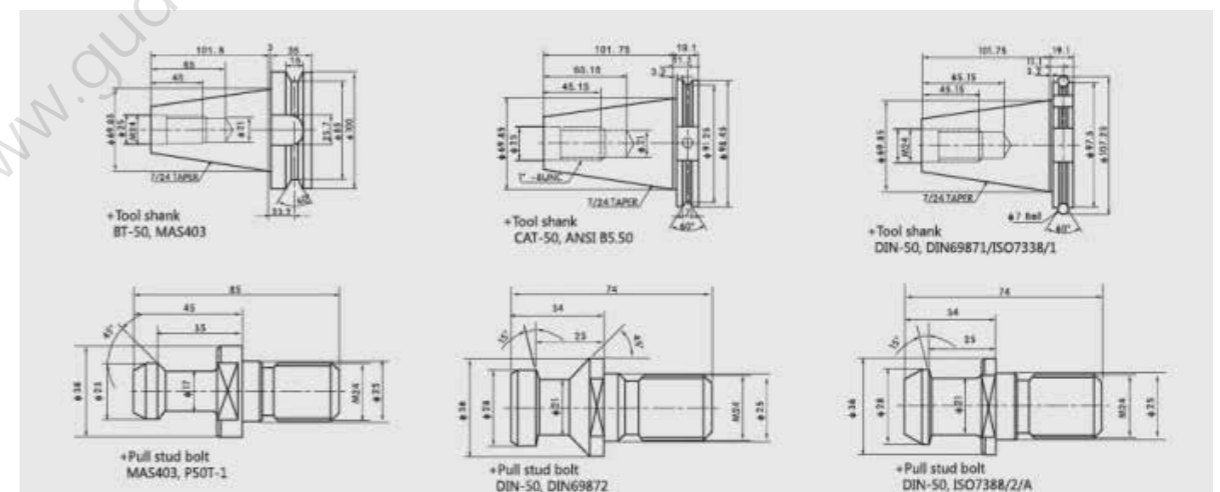



MECHANICAL SPECIFICATIONS

项目 ITEM	UNIT	GDC2013	GDC2018	GDC2518	GDC3018	GDC3022	GDC3028Z	GDC4028Z	GDC3032Z	GDC4032Z	GDC5032Z	GDC5040Z	GDC6532Z2	GDC6540Z2	GDC6547Z2	GDC8540Z2	GDC8547Z2	GDC10040Z2	GDC10047Z2
Travel																			
X-axis travel	mm	2000	2000	2500	3000	3000	3000	4000	3000	4000	5000	5000	6500	6560	6560	8560	8560	10060	10060
Y-axis travel	mm	1200	1800	1800	1800	2200	2800	2800	3200	3200	3200	4000	3200	4000	4700	4000	4700	4000	4700
Z-axis travel	mm	800	800	800	800	800	1000	1000	1000	1000	1000	1000	1200	1200	1200	1000	1200	1200	1200
Distance for spindle nose to work bench	mm	200-1000	200-1000	200-1000	200-1000	280-1080	200-1200	200-1200	200-1200	200-1200	200-1200	200-1200	200-1200	315-1515	315-1515	315-1515	315-1515	315-1515	315-1515
Distance between the double column	mm	1300	1900	1900	1900	2300	2300	2300	2700	2700	2700	3500	2700	3500	4200	3500	4200	3500	4200
Worktable size																			
Worktable size (X dedirection)	mm	2000	2020	2520	3020	3020	3020	4020	3020	4020	5020	5020	6020	6020	6020	8020	8020	10020	10020
Worktable size (Y direction)	mm	1100	1610	1610	1610	2010	2010	2010	2010	2410	2410	2410	2410	3010	3010	3010	3010	3010	3010
Worktable Max.load	kg	3500	6000	8000	10000	12000	12000	15000	12000	15000	18000	18000	20000	20000	20000	22000	22000	25000	25000
Spindle																			
Spindle speed	rpm	6000	6000	6000	6000	6000	6000	6000	6000	6000	6000	6000	6000	6000	6000	6000	6000	6000	6000
Spindle drive from		直连式	齿轮式	齿轮式	齿轮式	齿轮式	齿轮式	齿轮式	齿轮式	齿轮式	齿轮式	齿轮式	齿轮式	齿轮式	齿轮式	齿轮式	齿轮式	齿轮式	齿轮式
Spindle motor(continual/30min)	kW	15/18.5	15/18.5	15/18.5	15/18.5	15/18.5	15/18.5	22/26	22/26	22/26	22/26	22/26	22/26	22/26	22/26	22/26	22/26	22/26	22/26
Spindle taper	#ISO	BT50(ISO50)	BT50(ISO50)	BT50(ISO50)	BT50(ISO50)	BT50(ISO50)	BT50(ISO50)	BT50(ISO50)	BT50(ISO50)	BT50(ISO50)	BT50(ISO50)	BT50(ISO50)	BT50(ISO50)	BT50(ISO50)	BT50(ISO50)	BT50(ISO50)	BT50(ISO50)	BT50(ISO50)	BT50(ISO50)
Feed rate																			
Rapid feed rate X axis	mm/min	20000	15000	15000	15000	15000	15000	12000	15000	12000	10000	10000	8000	8000	8000	5000	5000	4000	4000
Rapid feed rate Y axis	mm/min	20000	15000	15000	15000	15000	15000	15000	15000	15000	15000	12000	15000	12000	12000	12000	12000	12000	12000
Rapid feed rate Z axis	mm/min	20000	12000	12000	12000	12000	12000	12000	12000	12000	12000	12000	12000	12000	12000	12000	12000	12000	12000
Cutting feed rate	mm/min	1~10000	1~6000	1~6000	1~6000	1~6000	1~6000	1~6000	1~6000	1~6000	1~6000	1~6000	1~6000	1~6000	1~6000	1~6000	1~6000	1~6000	1~6000
Tool magazine																			
Tool magazine capacity (optional)		24	24/32	24/32	24/32	24/32	24/32	24/32	24/32	24/32	24/32	24/32	24/32	24/32	24/32	24/32	24/32	24/32	24/32
Tool diameter / adjacent tool space	mm	Ø110/Ø200	Ø110/Ø200	Ø110/Ø200	Ø110/Ø200	Ø110/Ø200	Ø110/Ø200	Ø110/Ø200	Ø110/Ø200	Ø110/Ø200	Ø110/Ø200	Ø110/Ø200	Ø110/Ø200	Ø110/Ø200	Ø110/Ø200	Ø110/Ø200	Ø110/Ø200	Ø110/Ø200	Ø110/Ø200
Tool length	mm	400	400	400	400	400	400	400	400	400	400	400	400	400	400	400	400	400	400
Tool weight	kg	15	15	15	15	15	15	15	15	15	15	15	15	15	15	15	15	15	15
Accuracy																			
Positioning precision (JIS B 6338)	(JIS B 6338)	±0.015	±0.015	±0.015	±0.015	±0.015	±0.015	±0.015	±0.015	±0.015	±0.015	±0.015	±0.015	±0.015	±0.015	±0.015	±0.015	±0.015	±0.015
Reproducibility (JIS B 6338)	(JIS B 6338)	±0.005	±0.005	±0.005	±0.005	±0.005	±0.005	±0.005	±0.005	±0.005	±0.005	±0.005	±0.005	±0.005	±0.005	±0.005	±0.005	±0.005	±0.005
General specifications																			
electricity demand	kVA	50	60	60	60	60	60	60	60	60	60	60	60	60	60	60	60	60	60
Barometric pressure requirement (minimum)	kg/cm2	6	6	6	6	6	6	6	6	6	6	6	6	6	6	6	6	6	6
Hydraulic tank capacity (hydraulic pump)	l/kW	直驱电机	液压站	液压站	液压站	液压站	液压站	液压站	液压站	液压站	液压站	液压站	液压站	液压站	液压站	液压站	液压站	液压站	液压站
Lubricating oil tank capacity	l	6	6	6	6	6	6	6	6	6	6	6	6	6	6	6	6	6	6
Cutting fluid capacity (cutting fluid pump)	l	300	550	550	550	650	650	650	650	800	800	900	800	1000	1000	1000	1100	1000	1000
Machine net weight	T	16	20	23	25	35	36	38	38	43	48	52.5	64	70	74	85	90	98	103

Gudway reserves the right to alter the all designs,specifications and option list,without further notice.

Standard options

- Spindle temperature control system
- Working lamp
- Centralized automatic lubrication system
- Automatic power off function
- Cutting fluid cooling system (including pump and water tank)
- Electrical power off function
- Powerful twin screw chip curling machine
- Warning Light
- Crawler iron conveyor
- Transformer
- Fully Enclosed protective sheet metal
- Working Air soft
- Foundation horizontal block and foundation bolt
- Clean water gun

Purchase items

- Upgrade gear type 6000 rpm full tooth spindle
- External encoder
- Upgrade direct-coupled 8000/10000 rpm spindle
- RetroPting of electric cabinet box
- Upgrade built-in 20000 rpm high-speed spindle
- 24disc magazines
- Column heightening 200/300mm
- 32 chain type tool magazines
- Spindle center water outlet (limited gearbox optional)
- Fully enclosed outer cover sheet metal
- 3 axis Linear scale